

Features

HPE StoreEver LTO Ultrium Tape Drives



The family of HPE LTO Ultrium tape drives is Hewlett Packard Enterprise's premier line of backup devices. Based on the LTO Ultrium format, an open standard with a well-defined ten-generation roadmap, HPE LTO Ultrium tape drives offer customers the best choice for investment protection. With ultimate reliability and ease of use in mind, even at 100% duty cycles, HPE's rugged design builds on superior LTO technology and adds advanced features like hardware data encryption to create a new level of data protection. The tape drives employ dynamic data rate matching to adjust to the speed of the host, reducing wear and tear on both drive and media and increasing performance, even on slower hosts. HPE's ultra-durable soft-load feature automatically positions the data cartridge together with the highly reliable HPE leader-capture mechanism make your backup and restore operations more reliable.

The family of tape drives also features support for HPE Library and Tape Tools which provides HPE TapeAssure health monitoring, diagnostics, and performance optimization. Included with the HPE LTO Ultrium tape drives is the option to download Yosemite Server Backup Basic backup and recovery software providing a backup application to protect a single server. If data is critical to your business, protect it with an HPE LTO Ultrium tape drive.

HPE StoreEver LTO Ultrium Half-Height Tape Drives

HPE StoreEver LTO-7 Ultrium 15000 Tape Drive

The HPE LTO-7 Ultrium 15000 tape drive represents Hewlett Packard Enterprise's seventh-generation of LTO tape drive technology capable of storing up to 15TB (compressed 2.5:1) per cartridge while providing enterprise tape drive monitoring and management capabilities with HPE TapeAssure, ease of use with support for LTFS and AES 256-bit hardware data encryption easy-to-enable security to protect the most sensitive data and prevent unauthorized access of tape cartridges. Capable of data transfer rates up to 300 MB/sec (native), with Speed Matching feature further optimizes performance by matching speed of host to keep drives streaming and increase the reliability of the drive and media. HPE LTO Ultrium half-height drives are designed for server customers in direct attached storage (DAS) environments. For IT organizations with stringent, long-term data retention requirements, the Ultrium 15000's WORM (Write-Once, Read-Many) data protection feature offers a simple and secure method for archiving records as part of a compliance solution to meet the toughest of industry regulations. The Ultrium 15000 tape drives provide investment protection with full read and write backward support with LTO-6 media, and the ability to read LTO-5 cartridges. By more than doubling the native capacity of previous generation Ultrium drives, Hewlett Packard Enterprise customers now require fewer data cartridges to meet their storage needs, significantly reducing their IT costs and increasing their ROI.

Features

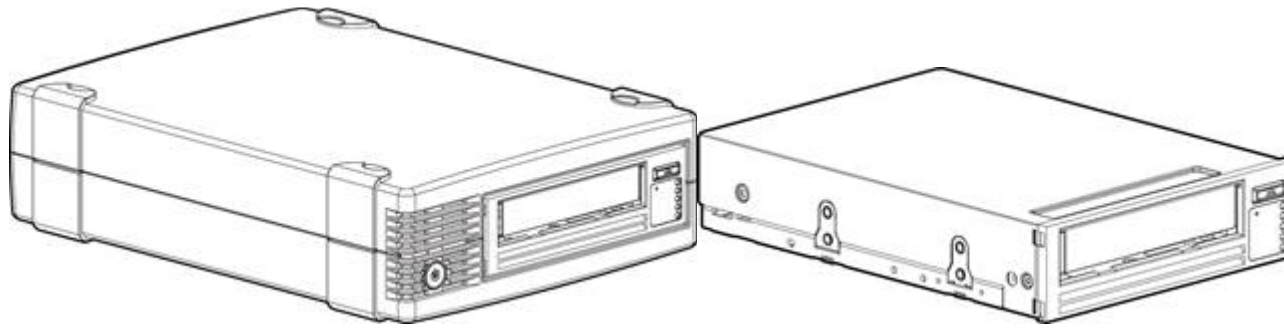

HPE StoreEver LTO-7 Ultrium 15000 External Tape Drive HPE StoreEver LTO-7 Ultrium 15000 Internal Tape Drive

HPE StoreEver LTO-6 Ultrium 6250 Tape Drive

The HPE LTO-6 Ultrium 6250 tape drive represents HPE's sixth-generation of LTO tape drive technology capable of storing up to 6.25TB (compressed 2.5:1) per cartridge while providing enterprise tape drive monitoring and management capabilities with HPE TapeAssure, ease of use with support for LTFS and AES 256-bit hardware data encryption easy-to-enable security to protect the most sensitive data and prevent unauthorized access of tape cartridges. Capable of data transfer rates up to 1.44TB/Hour (compressed 2.5:1), HPE's exclusive Data Rate Matching feature further optimizes performance by matching speed of host to keep drives streaming and increase the reliability of the drive and media. HPE LTO Ultrium half-height drives are designed for server customers in direct attached storage (DAS) environments. For IT organizations with stringent, long-term data retention requirements, the Ultrium 6250's WORM (Write-Once, Read-Many) data protection feature offers a simple and secure method for archiving records as part of a compliance solution to meet the toughest of industry regulations. The Ultrium 6250 tape drives provide investment protection with full read and write backward support with LTO-5 media, and the ability to read LTO-4 cartridges.

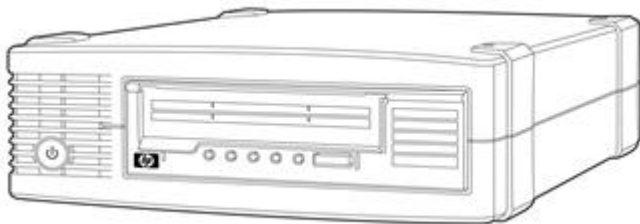

HPE StoreEver LTO-6 Ultrium 6250 External Tape Drive

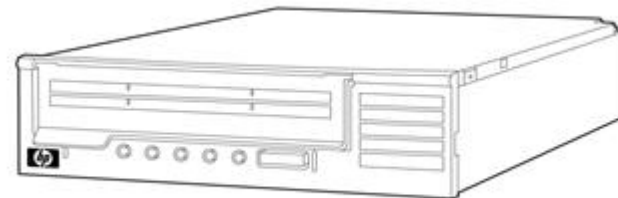

HPE StoreEver LTO-6 Ultrium 6250 Internal Tape Drive

Features

HPE StoreEver LTO-5 Ultrium 3000 Tape Drive

The HPE LTO-5 Ultrium 3000 represents Hewlett Packard Enterprise's fifth-generation of LTO tape drive technology capable of storing up to 3TB per cartridge while providing enterprise tape drive monitoring and management capabilities with HPE TapeAssure and AES 256-bit hardware data encryption easy-to-enable security to protect the most sensitive data and prevent unauthorized access of tape cartridges. Capable of data transfer rates up to 1TB/Hour HPE's exclusive Data Rate Matching feature further optimizes performance by matching speed of host to keep drives streaming and increase the reliability of the drive and media. HPE LTO Ultrium half-height drives are designed for server customers in direct attached storage (DAS) environments. For IT organizations with stringent, long-term data retention requirements, the Ultrium 3000's WORM (Write-Once, Read-Many) data protection feature offers a simple and secure method for archiving records as part of a compliance solution to meet the toughest of industry regulations. The Ultrium 3000 provides investment protection with full read and write backward support with LTO-4 media, and the ability to read LTO-3 cartridge.

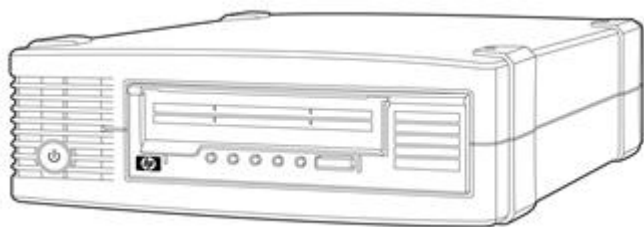

HPE StoreEver LTO-5 Ultrium 3000 External Tape Drive

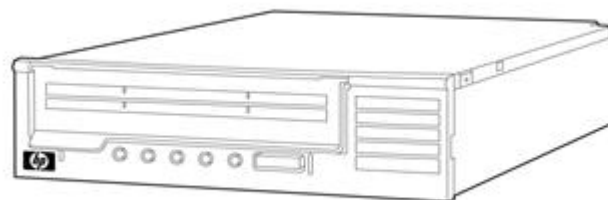

HPE StoreEver LTO-5 Ultrium 3000 Internal Tape Drive

HPE StoreEver LTO-4 Ultrium 1760 Tape Drive

The HPE LTO-4 Ultrium 1760 Tape Drive is Hewlett Packard Enterprise's fourth-generation of half-height LTO tape drive technology capable of storing up to 1.6 TB per cartridge in under 3 hours. HPE Ultrium half-height drives are designed for server customers in direct attached storage (DAS) environments. To further protect the most sensitive data, AES 256-bit hardware data encryption provides easy-to-enable security to prevent unauthorized access of tape cartridges. By using LTO-4 hardware data encryption, not only is data fully capable of being compressed therefore maximizing capacity, encrypted backups are completed without a loss in performance. Capable of data transfer rates up to 160 MB/sec, HPE's exclusive Data Rate Matching feature further optimizes performance by matching speed of host to keep drives streaming and enabling the fastest performance of any tape drive in the industry. For IT organizations with stringent, long-term data retention requirements, the Ultrium 1760's WORM (Write-Once, Read-Many) data protection feature offers a simple and secure method for archiving records as part of a compliance solution to meet the toughest of industry regulations. The Ultrium 1760 provides investment protection with full read and write support with LTO-4 and LTO-3 media, and the ability to read LTO-2 cartridge.

Features

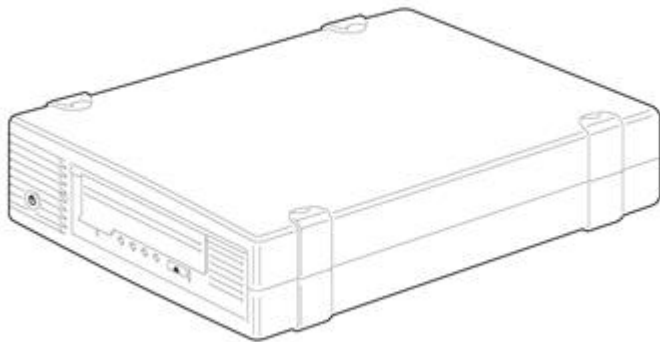

HPE StoreEver LTO-4 Ultrium 1760 External Tape Drive

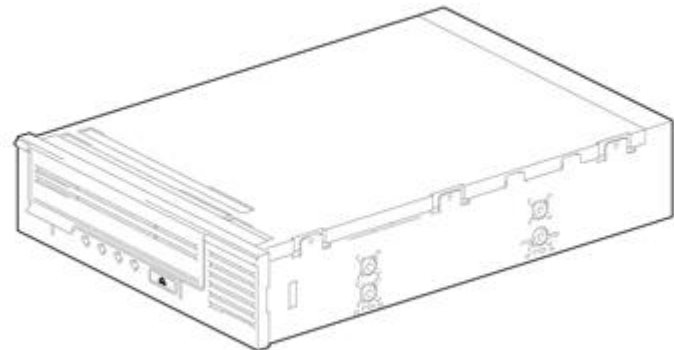

HPE StoreEver LTO-4 Ultrium 1760 Internal Tape Drive

HPE StoreEver LTO-3 Ultrium 920 Tape Drive

The HPE LTO-3 Ultrium 920 tape drive is HPE's third generation of half-height LTO tape drive technology. The Ultrium 920 delivers a compressed storage capacity of 800 GB per data cartridge and a compressed data transfer rate of 432 GB per hour, two and a half times faster than the previous generation LTO-2 Ultrium 448 tape drive. The Ultrium 920 is ideal for midrange and departmental servers. The Ultrium 920 Tape Drive is fully read and write compatible with all second-generation Ultrium drives and media and offers further investment protection through its backward-read compatibility with first-generation Ultrium media. For IT organizations with stringent, long-term data retention requirements, the Ultrium 920's WORM (Write-Once, Read-Many) data protection feature offers a simple and secure method for archiving records as part of a compliance solution to meet the toughest of industry regulations.

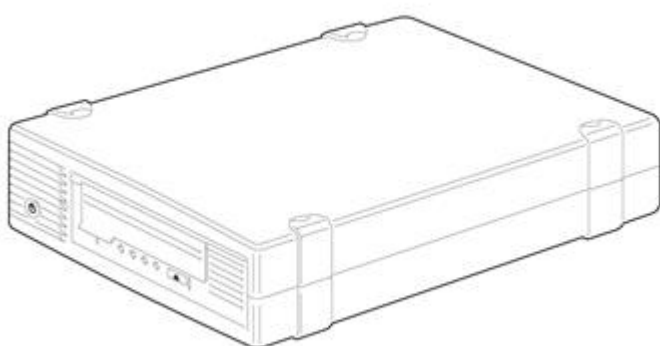

HPE StoreEver LTO-3 Ultrium 920 External Tape Drive

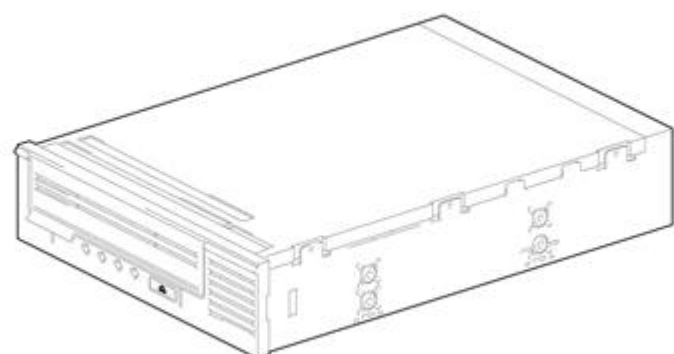

HPE StoreEver LTO-3 Ultrium 920 Internal Tape Drive

Features

HPE StoreEver LTO Ultrium Full-Height Tape Drives

HPE StoreEver LTO-6 Ultrium 6650 Tape Drive

HPE LTO-6 Ultrium 6650 Tape Drive sets new standards for capacity, performance, usability and manageability. The Ultrium 6650 tape drive represents HPE's sixth-generation of LTO tape drive technology capable of storing up to 6.25TB (compressed 2.5:1) per cartridge while providing enterprise tape drive monitoring and management capabilities with HPE TapeAssure, ease of use with support for LTFS and AES 256-bit hardware data encryption, easy-to-enable security to protect the most sensitive data and prevent unauthorized access of tape cartridges. Capable of data transfer rates up to 400MB/sec (compressed 2.5:1), HPE's exclusive Data Rate Matching feature further optimizes performance by matching speed of host to keep drives streaming and increase the reliability of the drive and media. The Ultrium 6650 provides investment protection with full read and write backward support with LTO-5 media, and the ability to read LTO-4 cartridges. By more than doubling the compressed capacity of previous generation Ultrium drives, Hewlett Packard Enterprise customers now require fewer data cartridges to meet their storage needs, significantly reducing their IT costs and increasing their ROI.

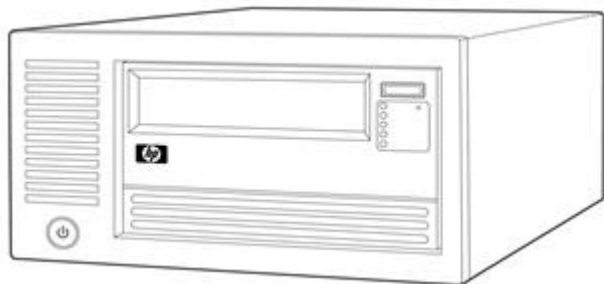

HPE StoreEver LTO-6 Ultrium 6650 External Tape Drive

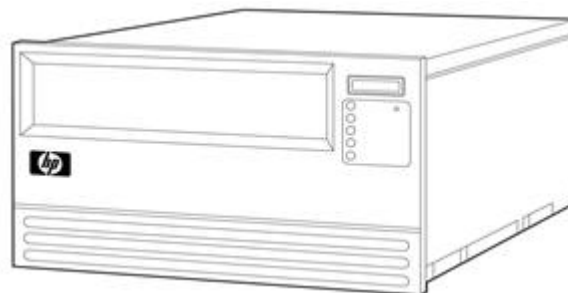

HPE StoreEver LTO-6 Ultrium 6650 Internal Tape Drive

HPE StoreEver LTO Ultrium Full-Height Tape Drives

HPE StoreEver LTO-5 Ultrium 3280 Tape Drive

The Ultrium 3280 represents HPE's fifth-generation of LTO tape drive technology capable of storing up to 3TB per cartridge while providing enterprise tape drive monitoring and management capabilities with HPE TapeAssure, ease of use with support for LTFS and AES 256-bit hardware data encryption, easy-to-enable security to protect the most sensitive data and prevent unauthorized access of tape cartridges. Capable of data transfer rates up to 280MB/sec, HPE's exclusive Data Rate Matching feature further optimizes performance by matching speed of host to keep drives streaming and increase the reliability of the drive and media. The Ultrium 3280 provides investment protection with full read and write backward support with LTO-4 media, and the ability to read LTO-3 cartridge.

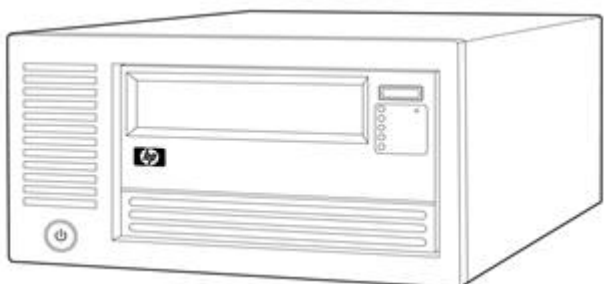

HPE StoreEver LTO-5 Ultrium 3280 External Tape Drive

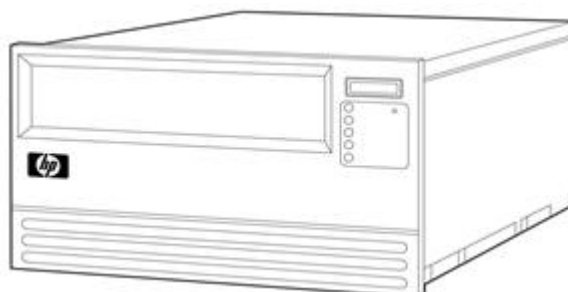

HPE StoreEver LTO-5 Ultrium 3280 Internal Tape Drive

Key Features

- High-Capacity: Large-capacity drive capable of storing up to 15TB (with LTO-7) of compressed storage on

Features

a single cartridge, requiring fewer data cartridges to meet storage needs, significantly reducing IT and archiving costs

- Ease of use with LTFS and HPE StoreOpen - providing a self-describing file system with HPE LTO-5 or higher generation cartridges, which enables the combined archiving benefits of application independence, transportability and protection from obsolescence.
- Secure: AES 256 bit data encryption and support for WORM media provide a secure method for long-term retention of critical data records
- Fast: Fast data transfer rate up to 300 MB/sec (LTO-7 native) to meet demands of even the tightest backup window
- Manageable: HPE Library and Tape Tools (LTT) provides HPE TapeAssure health monitoring and operational information on performance and utilization for peace of mind and to allow you to optimize your configuration to get the most out of your drives and media as well as help with installation and troubleshooting
- Affordable: high capacity combined with low media cost delivers an exceptionally low cost of ownership and ensures a faster return on investment
- Reliable: HPE's exclusive data rate matching feature automatically adjusts the drive's read and write speed based on the server and network environment, which increases performance, reduces mechanical wear on the drive, and extends tape life. Soft-load feature automatically takes the data cartridge and moves it into the load position. Advanced tape leader capture design ensures fail-safe cartridge loading. Active head cleaning provides automated cleaning that increases head life and reduces the need for using the cleaning cartridge. Lower power consumption for maximum reliability with minimum environmental costs
- Compatible: qualified/tested on all industry-leading operating systems, backup software and servers. Fully read-and-write compatible with LTO Ultrium drives and media from other manufacturers
- Agile: choice of models including internal, external and rack-mount to meet your backup configuration needs inside and outside of the server
- Value: Includes the option to download Yosemite Server Backup Basic backup and recovery software, see: www.barracudaware.com/ysbbasic
- Investment Protection: delivers a compelling technology roadmap that offers higher capacity and performance tape solutions with backward read and write compatibility for previous drive generations
- Open: based on the LTO technology open standard, delivering customers a greater choice of vendors and solutions without compromising compatibility across Ultrium products

Product Highlights

LTO Ultrium
Technology

Linear Tape-Open technology was developed by three leaders in the storage industry - Hewlett Packard Enterprise, IBM, and Quantum - who brought together their combined expertise in tape technology to develop an entirely new format based on the best of existing technologies. Because LTO Ultrium technology was a new format, it required no cumbersome support of legacy formats, so it could be designed without compromising on reliability or performance. The LTO Program, a consortium of the three technology provider companies, has developed a well-defined ten-generation roadmap.

Ultrium LTO-3, LTO-4, LTO-5 and LTO-6 tape drive technologies from Hewlett Packard Enterprise use a linear format of 704 tracks, 896 tracks 1280 tracks and 2176 tracks (respectively), writing sixteen tracks simultaneously. Ultrium LTO-7 tape drive features a breakthrough in recording technology by writing thirty-two tracks simultaneously on a linear format of 3584 tracks. The data is written in a serpentine pattern; the tape reverses direction after each set of tracks is written. This provides higher density recording, enabling customers to lower costs and increase efficiency by storing more data on a single tape in an industry standard format.

The LTO standard for backward compatibility is to write back one generation and read back two generations; therefore:

- First-generation LTO Ultrium drives (HPE Ultrium 230, HPE Ultrium 232) read and write LTO 1 media
- Second-generation LTO Ultrium drives (HPE Ultrium 460, HPE Ultrium 448) read and write LTO 1 and LTO 2 media.
- Third-generation LTO Ultrium drives (HPE Ultrium 920, Ultrium 960) read and write LTO 2 and LTO 3 media and also read LTO 1 media.
- Fourth-generation LTO Ultrium drives (Ultrium 1840, Ultrium 1760) read and write LTO 3 and LTO 4 media and also read LTO 2 media.
- Fifth-generation LTO Ultrium drives (Ultrium 3280, Ultrium 3000) read and write LTO 4 and LTO 5 media and also read LTO 3 media.
- Sixth-generation LTO Ultrium drives (Ultrium 6650, Ultrium 6250) read and write LTO 5 and LTO 6 media and also read LTO 4 media.
- Seventh-generation LTO Ultrium drives (Ultrium 15000) read and write LTO 6 and LTO 7 media and also read LTO 5 media

As part of the LTO open standard, all HPE tape drives and media offer the same standards of compatibility with tape drives and media manufactured by other LTO vendors.

LTO data compression (LTO-DC) is an enhanced version of Advanced Lossless Data Compression (ALDC) hardware compression. Compression is automatically turned off if the compressed data would cause an overall expansion in data size, hence optimizing the available capacity on the media. Data compression is also turned off if data is found to be uncompressible; thus, allowing for better data scans. The system is used in all LTO Ultrium tape drives.

The decision about which tape technology you should buy next should be based on your future, not your past, investment. Choose the LTO Ultrium format when you need the following advantages:

- Maximum reliability, capacity and performance
- Compatibility with a broad range of operating systems and servers (e.g., a mixed

Product Highlights

system environment)

- A legacy-free technology that uses the best attributes from a wide range of tape technologies without any compromises for backward compatibility requirements
- A solid roadmap for future generations of the technology
- An open format available from multiple vendors
- Lowest media cost of any 'superdrive' tape technology

Hardware Based Encryption

HPE LTO-4, 5, 6 and 7 LTO Ultrium tape drives support hardware-based encryption to enable greater levels of security:

- AES 256-bit Encryption
 - Easy-to-enable encryption for a secure backup
 - Helps prevent unauthorized accessed of tape media if cartridges are lost or stolen
 - Eliminates the need to purchase and manage additional h/w
- No loss in performance of backup
- The Yosemite Server Backup Basic backup and recovery software supports LTO-4, LTO-5, LTO-6 and LTO-7 encryption and makes writing encrypted backups simple. A passphrase is entered and Yosemite Server Backup Basic creates and manages the encryption key.

TapeAssure

HPE TapeAssure makes managing, optimizing and archiving on the HPE LTO Ultrium tape drives easier. This tool provides additional management and monitoring capabilities including:

- Life and health information for media and drives
- Information on media and drive utilization and operational performance
- Notifications of drive and media characteristics that fall below Hewlett Packard Enterprise recommended standards

TapeAssure health reports and alerts give you peace of mind knowing the condition of the drives, the tapes and the data on each tape. TapeAssure monitors every backup to ensure the highest standards of reliability, sends alerts when these standards are not met, and ensures that you can maintain the drives and tapes used in an archive environment to have the highest integrity.

HPE TapeAssure is included as part of HPE Library and TapeTools for Windows users from LTT 5.0 onwards. Instructions and downloads of HPE Library and Tape Tools are available at: <http://www.hpe.com/storage/tapetools>

Product Highlights

Linear Tape File System (LTFS)

LTFS makes tape self-describing, file-based, and easy-to-use, it also provides users with the ability to use standard file operations on tape media for accessing, managing and sharing files with an interface that behaves just like a hard disk. In addition, LTFS provides the ability to share data across platforms, as you would with a USB drive or memory stick. Simply load a tape into the drive, mount it into the file system, and it becomes visible as a disk.

For more information, including user guide, downloads and compatibility, visit:
<http://www.hpe.com/storage/lvfs>

HPE StoreOpen Standalone

HPE StoreOpen Standalone is a free software application that helps LTFS users to use and manage single tape drives.

Available for Windows and Mac environments, it provides a native GUI with a familiar look and feel. It is installed automatically as part of the LTFS package and it completely removes the need for low-level terminal commands by guiding users through the full process of select, prepare and mount an LTFS cartridge.

For more information, including user guide, downloads and compatibility, visit:
<http://www.hpe.com/storage/HPStoreOpen>

Data Rate Matching

Data Rate Matching combines sophisticated buffer management with HPE's exclusive Variable Tape Speed technology to allow the tape drive to match its transfer rate to the host speed dynamically and continuously across the wide range of transfer rates. This feature ensures that the tape drive continues to stream data regardless of the environment, and brings two big advantages:

- It optimizes backup performance, regardless of the speed of the host or the network
 - It minimizes rewinding and repositioning of the tape, reducing wear and increasing reliability
-

Product Highlights

WORM (Write-Once, Read-Many) Drive and Media Support

Critical to the success of data retention policies in highly regulated environments is the ability to store and manage data in an unalterable state. Following stringent guidelines set forth by regulatory agencies such as the SEC and HIPPA, IT organizations must now integrate new solutions and policies that can verify the integrity of stored data for periods that can extend well beyond seven years.

LTO generation 3 and higher tape drives feature the ability to archive and store data in a non-rewriteable format that meets the most stringent regulatory guidelines. Using a combination of integrated fail-safe features in the drive firmware, cartridge memory, and tape formatting, LTO Ultrium drives can archive large amounts of data for periods of up to 30 years in a secure, untampered state. Since all LTO generation 3 and higher tape drives include support for both rewritable and WORM media, IT organizations can now easily integrate a secure, long-term archiving solution into their current data protection strategy. As compared to other technologies that feature support for WORM storage, LTO tape drives offers the advantages of:

- A single drive to support all backup and archiving needs
- Two distinctive tape cartridges to easily distinguish and manage both rewriteable and WORM data cartridges
- A specially designed WORM data cartridge with multiple integrated fail-safe features to prevent accidental or intentional overwriting of data
- High-capacity, low-cost HPE WORM media that can store up to 15TB (LTO-7) of data on a single data cartridge
- Support from many backup and archiving software vendors, providing the most comprehensive and mainstream support in the industry
- The LTO open standard that offers greater choice and compatibility across all third-generation Ultrium products

NOTE: While all HPE LTO generation 3 and higher tape drives support LTO Ultrium WORM media, some third-generation LTO Ultrium tape drives from other manufacturers may not include read and write support for LTO Ultrium WORM media. For non-HPE LTO-3 and LTO-4 tape drives, please check the manufacturers' specifications to ensure this support is provided if you are using your WORM media. If WORM support is not provided, the drive will eject the WORM tape cartridge immediately upon insertion into the tape drive.

Product Highlights

Included Software

The HPE Ultrium tape drives provide the option to download Yosemite Server Backup Basic backup and recovery software. It is an easy-to-use backup and recovery application that is installed in minutes and includes all the features needed to protect a single machine by backup to a HPE tape drive. Yosemite Server Backup Basic includes pre-defined and customizable media rotation schemes so you can define when you backup and how long your backups are retained, while easily managing your LTO data cartridges. Up to 4 parallel data streams keep the high-speed Ultrium tape drives streaming. Yosemite Server Backup Basic supports all the features of the Ultrium tape drives. LTO generation 4 and higher data encryption can be specified for any backup job and is configured using the easy-to-manage interface. Backup to LTO WORM media is supported. Backup data compression can be turned on or off as part of the backup job specifications.

For more information please visit:

www.barracudaware.com/ysbbasic

NOTE: Yosemite Server Backup Basic comes with 30 days of free Maintenance and Support. After that time, customers have the option to upgrade to a retail version with Maintenance and Support.

NOTE: Yosemite Server Backup Basic replaces Data Protector Express Basic as the Backup & Recovery software option with HPE LTO Ultrium tape drives.

If the HPE Ultrium tape drive is for a large environment that requires UNIX support and/or enterprise class application and feature support then HPE Data Protector is the recommended backup and recovery software. There is no upgrade path from Yosemite Server Backup Basic or Data Protector Express Basic or Data Protector Express to Data Protector. If current or future requirements will require Data Protector, this software should be installed from day 1. For more information and evaluation software please visit: <http://www.hpe.com/software/dataprotector>.

HPE Ultrium Storage Media

Hewlett Packard Enterprise recommends that you use HPE-branded cartridges in your HPE Ultrium tape drive to assure the highest level of protection for your valuable data. Our test program for HPE Ultrium media is the most thorough and comprehensive in the industry.

All HPE cartridges must satisfy an exhaustive battery of additional tests that relate directly to real life situations, where real data and real businesses are at stake. The benefit of the HPE brand specification for media is consistent quality. Through the testing of thousands of HPE drives and HPE cartridges, the ideal formulation for backup performance is defined and then continuously monitored. This hugely resource-intensive process is unique to Hewlett Packard Enterprise and affords deep insight into the HPE+HPE backup solution for a wide range of environments and duty cycles. Your best choice for ease of support and maximum dependability is to use HPE-branded Ultrium cartridges at all times.

Product Highlights

Diagnostics

HPE LTO Ultrium tape drives and automation are supported by HPE Library and Tape Tools (LTT). This tool is intended to help in the installation and maintenance of HPE tape drives and devices, including:

- Verifies installation of the drive
- Test/verify the health of the drive and media
- Provides Hewlett Packard Enterprise support with detailed device information
- Multiple options for finding and upgrading new firmware
- Performance optimization and recommendations
- Included with each Ultrium tape drive and available via free download supporting all HPE tape products

Instructions and downloads of HPE Library and Tape Tools are available at:

<http://www.hpe.com/support/tapetools>

HPE Library and TapeTools includes HPE TapeAssure monitoring for Windows users from LTT 5.0 onwards.

Compatibility

Hewlett Packard Enterprise extensive compatibility testing program assures that your HPE LTO Ultrium tape drive works with leading servers, operating systems, and backup applications - and not just those sold by Hewlett Packard Enterprise. HPE LTO Ultrium tape drives work seamlessly on many platforms, making them especially suitable if you have a mixed system environment. For the latest list of servers, workstations, operating systems, and backup software that support HPE Ultrium tape drives, check the tape backup compatibility pages on our Web site at: <http://www.hpe.com/storage/BURCompatibility>

Server Compatibility HPE Ultrium tape drives are supported on the following classes of HPE systems:

- HPE ProLiant DL servers
- HPE ProLiant ML servers
- HPE Integrity servers
- HPE 9000 servers
- HPE AlphaServers
- HPE Inc. workstations

HPE Ultrium tape drives are also supported on server platforms from third-party manufacturers including:

- Dell
- IBM
- Sun

For details of which tape drive models work with which systems, including third-party systems, visit: <http://www.hpe.com/Storage/BURCompatibility> for the latest hardware compatibility information.

OS Support Microsoft® Windows, HPE-UX, Tru64, Red Hat Linux, SUSE Linux, IBM-AIX, Sun Solaris and other operating systems.

NOTE: Please visit: <http://www.hpe.com/Storage/BURCompatibility> for the latest compatibility information.

Backup Software Support Supported with HPE Data Protector, Yosemite Server Backup, ARCserve Backup, EMC NetWorker, EMC Retrospect, IBM Tivoli Storage Manager, Symantec NetBackup, Symantec Backup Exec, Symantec Backup Exec, BakBone NetVault, Commvault Simpana, Tolis Group BRU, Archiware P5, Qstar Archive Manager and others.

NOTE: Please visit: <http://www.hpe.com/Storage/BURCompatibility> for the latest compatibility information.

Compatibility

SAS Installation

HPE SAS tape drives are available as internal and external models. Both models are supplied with SAS cables that allows you to connect to an internal port (if available) on the embedded SAS controller inside the server.

Some server models will allow direct connect to a spare SAS connector on the native SAS controller. Other servers which do not have a spare connector might require you to reconfigure hard disk drive bays and in a few instances, you may also lose the use of one of the hard disk drive bays and will need to rebuild your RAID configuration. In these configurations the simple, recommended solution is connecting to an option SAS host bus adapter and optional SAS cable.

For the most up-to-date information about recommended SAS HBAs and supported cabling configurations with your make and model of server, always refer to:
<http://www.hpe.com/Storage/BURACompatibility>

Cables and Termination

All cables required for a typical internal and external connection to Hewlett Packard Enterprise servers are provided with your tape drive. For non-Hewlett Packard Enterprise servers, please consult your manufacturers' server specifications to determine if the cable provided with your LTO Ultrium tape drive is appropriate for use with that server.

SAS-based HPE LTO Ultrium models ship with SAS cable which allows direct attach from embedded SAS controller.

NOTE: Visit: <http://www.hpe.com/Storage/BURACompatibility> for the latest compatibility information.

Performance Tuning

Use HPE Library and Tape tools to assist in this area at:
<http://www.hpe.com/storage/tapetools>

Device performance test - will run data to an LTO drive direct from memory to prove the drive is capable of high performance if the data supply rate is fast enough.

System performance test for backup will read data from your primary storage device e.g. EVA disk array, and tell you how fast the array can supply multiple streams of data

System performance test for restore, this tool generates data of a known size and compressibility for benchmarking purposes.

Service and Support, HPE Support, and Warranty Information

Warranty and Services Hewlett Packard Enterprise provides a 3-year, next-day, product exchange, limited included with the warranty for all the Ultrium Tape Drives, plus 9x5 phone support for the duration of the product warranty.

For more information about Hewlett Packard Enterprise's Global Limited Warranty and Technical Support, visit:

ftp://ftp.compaq.com/pub/products/storageworks/warranty/EN_321708-008.pdf

HPE Support Services: Packaged server and storage services for increased uptime, productivity and ROI
When you buy HPE server and storage products and solutions, it's also a good time to think about what levels of support you may need. Our portfolio of service options reduce deployment and management worries while helping you get the most out of your server and storage investments. We take a holistic approach to your environment, bridging servers, blades, storage, software and network infrastructures with our packaged HPE Support Services for servers and storage.

Protect your business beyond warranty

When it comes to robustness and reliability, standard computing equipment warranties have matured along with technology. Good news that can also create problems stemming from depending on standard warranties designed to only protect against product defects and some downtime causes. Using a standard approach to warranty uplifts, such as HPE Support Services, helps reduce downtime risks and provides operational consistency for mission-critical and standard business computing.

HPE Support Services: Upgrading or extending standard server and storage warranties cost effectively
HPE Support Services offer a standard reactive hardware and software support services suite sold separately. The portfolio also provides a combination of integrated proactive and reactive services, such as Proactive Care Service and Proactive Care Advanced. In addition with HPE Proactive Select, you can acquire the specific proactive constancy and technical services. HPE Proactive Select menu offers a broad set of service options that you can mix and match depending on your specific requirements. Proactive service options include offers for server, storage, network, SAN device, software, environment and education services.

HPE server and storage lifecycle support services offers a full spectrum of customer care—from technology support to complex migrations to complete managed services. HPE Factory Express provides customization, integration and deployment services for turnkey solutions. HPE Education Services offer flexible, comprehensive training on to help your IT staff get the most out of your server and storage investments. HPE Financial solutions extend innovative financing and cost-effective asset management programs—from purchase to equipment retirement.

Learn more: www.hpe.com/services/storage

NOTE: Support Services availability may vary by product and country.

HPE Support Services are sold by Hewlett Packard Enterprise and Hewlett Packard Enterprise Authorized Service Partners:

- Services for customers purchasing from Hewlett Packard Enterprise or an enterprise reseller are quoted using Hewlett Packard Enterprise order configuration tools.
- Customers purchasing from a commercial reseller can find HPE Support Services at

Service and Support, HPE Support, and Warranty Information

<http://www.hpe.com/services/storage>

Recommended HPE Support Services for optimal satisfaction with your HPE product.

Recommended Support

HPE Foundation Care 24x7 connects you to Hewlett Packard Enterprise 24 hours a day, seven days a week for assistance on resolving issues - hardware onsite response within four hours and software call back within two hours after opening your case. Three years' coverage recommended with HPE Support Service.

HPE Foundation Care 24x7 connects you to Hewlett Packard Enterprise 24 hours a day, seven days a week for assistance on resolving issues - hardware onsite response within four hours and software call back within two hours after opening your case. Three years' coverage recommended with HPE Support Service.

Important Notice for Tape Drives Installed in a 1U or 3U Rack Mount Kit **NOTE:** These services do not apply to Tape Drives mounted in a 1U or 3U Rack Mount Kit. The HPE Rack Mount Kit Support Service covers the all possible configurations of Tape Drives. Hence the services for 1U & 3U Rack Mount Kit covers all encumbering drives.

Please follow the following url for the correct Support Services and descriptions:

http://h18000.www1.hpe.com/products/QuickSpecs/10854_div/10854_div.pdf

Important Notice for Internal Tape Drives Installed in an HPE Server

NOTE: These services do not apply to Internal Tape Drives because they do not have Supports associated with them if they are mounted in an HPE Server. Hence the services for the HPE Server covers all encumberant drives.

Please follow the following url for the correct Support Services and descriptions:

For ProLiant use:

<http://h18000.www1.hpe.com/products/QuickSpecs/ProductBulletin.html>

For BCS use:

<http://h18000.www1.hpe.com/products/QuickSpecs/ProductBulletin.html>

Recommended Deployment

HPE Installation Service

For smooth startup and better business outcomes, HPE Hardware Installation - this service provides initial hardware installation of your product into your technology environment (system configuration is not included). In today's new era of business technology- customers can trust the services professionals at Hewlett Packard Enterprise to work collaboratively with them, putting our strategic and technical know-how to work across their entire infrastructure.

- Allows your IT resources to stay focused on their core tasks and priorities
- Reduces implementation time, impact and risk to your storage environment

<http://h71028.www7.hpe.com/ERC/downloads/5981-9356EN.pdf>

Service and Support, HPE Support, and Warranty Information

eSupport

HPE eSupport is a portfolio of technology-based services that assist you with managing your business environment - from the desktop to the data center.

Support Portal

The Hewlett Packard Enterprise support portal provides one-stop access to the information, tools and services you need to manage the daily operations of your IT environment.

Features include:

- Access to self-solve tools (including search technical knowledge base)
- Efficient logging and tracking of support cases
- Collaboration with other business and IT professionals
- Download of patches and drivers
- Access to diagnostic tools
- Proactive notification of relevant information

Access to certain features of the support portal requires a Hewlett Packard Enterprise service agreement. To access the support portal, visit: <http://www.hpe.com/support>

Customer Technical Training

HPE Education Services

In today's cost-conscious business environment, IT professionals, developers, consultants and users face an interesting challenge: how to keep up with the latest technologies and expand important skills while delivering profitable results on current projects. To help address this challenge, Hewlett Packard Enterprise offers innovative training solutions that help keep you up-to-date on virtualization, server, storage, Insight Control, Citrix, Microsoft® and open source/Linux-related topics-while spending less time away from business-critical activities.

HPE Services Awards

HPE Technology Services continues to be recognized for service and support excellence by customers, partners, industry organizations and publications around the world. Recent honors and award reflect our services team's dedications, technical expertise, professionalism and uncompromising commitment to customer satisfaction.

Additional Services Information

To learn more on HPE ProLiant servers, HPE BladeSystem servers and HPE storage products, please contact your Hewlett Packard Enterprise sales representative or Hewlett Packard Enterprise Authorized Channel Partner. Or visit: <http://www.hpe.com/services/proliant> or <http://www.hpe.com/services/bladeSystem> or <http://www.hpe.com/services/storage>

Options

HPE LTO Ultrium Full-Height Tape Drives

	Model Name/Kit Contents Description	Part Number
LTO-6 Ultrium 6650 tape drives	LTO-6 Ultrium 6650 SAS internal <ul style="list-style-type: none"> HP StoreEver LTO-6 Ultrium 6650 SAS Internal Tape Drive <p>NOTE: 0D1 will appear after this part number on your sales order if factory integration into a server is indicated.</p>	EH963A
	LTO-6 Ultrium 6650 SAS External <ul style="list-style-type: none"> HP StoreEver LTO-6 Ultrium 6650 SAS External Tape Drive 	EH964A
LTO-5 Ultrium 3280 tape drives	LTO-5 Ultrium 3280 SAS Internal <ul style="list-style-type: none"> HP StoreEver LTO-5 Ultrium 3280 SAS Internal Tape Drive <p>NOTE: 0D1 will appear after this part number on your sales order if factory integration into a server is indicated.</p>	EH899B
	LTO-5 Ultrium 3280 SAS External <ul style="list-style-type: none"> HP StoreEver LTO-5 Ultrium 3280 SAS External Tape Drive 	EH900B

HPE LTO Ultrium Half-Height Tape Drives

	Model Name/Kit Contents Description	Part Number
LTO-7 Ultrium 15000 tape drives	LTO-7 Ultrium 15000 SAS Internal <ul style="list-style-type: none"> HPE StoreEver LTO-7 Ultrium 15000 Internal Tape Drive Yosemite Server Backup Basic (option to download) HPE LTO-7 Ultrium 15 TB RW Data Cartridge mini-SAS SFF8482 to SFF8087 cable Documentation <p>NOTE: 0D1 will appear after this part number on your sales order if factory integration is indicated.</p>	BB873A
	LTO-7 Ultrium 15000 SAS Internal TAA Compliant <ul style="list-style-type: none"> HPE StoreEver LTO-7 Ultrium 15000 Internal Tape Drive Yosemite Server Backup Basic (option to download) HPE LTO-7 Ultrium 15 TB RW Data Cartridge mini-SAS SFF8482 to SFF8087 cable Documentation <p>NOTE: 0D1 will appear after this part number on your sales order if factory integration is indicated.</p>	BB953A
	LTO-7 Ultrium 15000 SAS External <ul style="list-style-type: none"> HPE StoreEver LTO-7 Ultrium 15000 External Tape Drive Yosemite Server Backup Basic (option to download) HPE LTO-7 Ultrium 6.25 TB RW Data Cartridge mini-SAS High Density to SFF8087 cable Documentation <p>NOTE: 0D1 will appear after this part number on your sales order if factory integration is indicated.</p>	BB874A

Options

factory integration is indicated.

LTO-6 Ultrium 6250 tape drives	LTO-6 Ultrium 6250 SAS Internal	<ul style="list-style-type: none"> HP StoreEver LTO-6 Ultrium 6250 Internal Tape Drive EH969A NOTE: 0D1 will appear after this part number on your sales order if factory integration is indicated.
	LTO-6 Ultrium 6250 SAS External	<ul style="list-style-type: none"> HP StoreEver LTO-6 Ultrium 6250 External Tape Drive EH970A
	HP StoreEver LTO-6 Ultrium 6250 Tape Drive in 1U Rack-mount Kit C0L99A	<ul style="list-style-type: none"> 6Gb SAS rack-mountable enclosure (1U) with power supply and fan rail kit one internal LTO-6 Ultrium 6250 SAS tape drive power cord Yosemite Server Backup Basic (option to download) HPE LTO-6 Ultrium 6.25 TB RW Data Cartridge Documentation NOTE: 0D1 will appear after this part number on your sales order if factory integration into a rack is indicated.
LTO-5 Ultrium 3000 tape drives	LTO-5 Ultrium 3000 SAS Internal	<ul style="list-style-type: none"> HP StoreEver LTO-5 Ultrium 3000 SAS Internal Tape Drive EH957B NOTE: 0D1 will appear after this part number on your sales order if factory integration is indicated.
	LTO-5 Ultrium 3000 SAS External	<ul style="list-style-type: none"> HP StoreEver LTO-5 Ultrium 3000 SAS External Tape Drive EH958B
	HP StoreEver LTO-5 Ultrium 3000 SAS Tape Drive in 1U Rack-mount EJ014B	<ul style="list-style-type: none"> 6Gb SAS rack-mountable enclosure (1U) with power supply and fan rail kit one internal LTO-5 Ultrium 3000 SAS tape drive power cord Yosemite Server Backup Basic (option to download) HPE LTO5 Ultrium 3 TB RW Data Cartridge Documentation NOTE: 0D1 will appear after this part number on your sales order if factory integration into a rack is indicated.
LTO-4 Ultrium 1760 tape drives	Model Name/Kit Contents Description Part Number	
	LTO-4 Ultrium 1760 SAS Internal	<ul style="list-style-type: none"> HP StoreEver LTO-4 Ultrium 1760 SAS Internal WW Tape Drive EH919B NOTE: 0D1 will appear after this part number on your sales order if factory integration is indicated.
	LTO-4 Ultrium 1760 SAS External	<ul style="list-style-type: none"> HP StoreEver LTO-4 Ultrium 1760 SAS External Tape Drive EH920B
	Model Name/Kit Contents Description Part Number	
	LTO-3 Ultrium 920 SAS Internal	

Options

- HP StoreEver LTO-3 Ultrium 920 SAS Internal Tape Drive EH847B
NOTE: 0D1 will appear after this part number on your sales order if factory integration is indicated.

LTO-3 Ultrium 920 SAS External

- HP StoreEver LTO-3 Ultrium 920 SAS External Tape Drive EH848B

Host Bus Adapters, Controllers, and Accessories for ProLiant Servers

HP SC11Xe Ultra320 Single Channel/ PCIe x4 SCSI Host Bus Adapter 412911-B21
NOTE: Recommended SCSI HBA for connecting Ultrium tape drives to G6/G7/Gen8 ProLiant servers.

HPE H241 Host Bus Adapter 726911-B21
NOTE: Recommended SAS HBA for connecting External LTO Ultrium tape drives to Gen9 ProLiant servers

HPE H240 Host Bus Adapter 726907-B21
NOTE: Recommended SAS HBA for connecting Internal LTO Ultrium tape drives to Gen9 ProLiant servers

HPE H222 Host Bus Adapter 650926-B21
NOTE: Recommended SAS HBA for connecting LTO Ultrium tape drives to Gen8 ProLiant servers.

HP Smart Array P222/512 FBWC 6Gb 1-port Int/1-port Ext SAS Controller 631667-B21
NOTE: SAS HBA for connecting LTO Ultrium tape drives to Gen8 ProLiant servers.

Media

HP LTO1 Ultrium 200GB RW Data Tape C7971A
NOTE: Write and read support for Ultrium 230, Ultrium 232, Ultrium 448 and Ultrium 460. Read support for Ultrium 920 and Ultrium 960.

HP LTO2 Ultrium 400GB RW Data Tape C7972A
NOTE: Write and read support for Ultrium 448, Ultrium 460, Ultrium 920 and Ultrium 960. Read support for LTO-4 Ultrium1840 and Ultrium 1760.

HP LTO-3 Ultrium 800 GB Re-writable Data Cartridge C7973A
NOTE: Write and read only support for Ultrium 920 and Ultrium 960, LTO-4 Ultrium 1840 and Ultrium 1760. Read support for LTO-5 Ultrium 3280 and Ultrium 3000.

HP LTO-3 Ultrium 800 GB WORM Data Cartridge C7973W
NOTE: This data cartridge supports Write-Once recording format for LTO-3 and LTO-4 drives, and Read-Many for LTO-3, LTO-4 and LTO-5 drives. Data recorded to this data cartridge cannot be overwritten.

HP LTO4 Ultrium 1.6TB Read/Write Data Cartridge C7974A
NOTE: Write and read support for LTO-4 Ultrium 1840, LTO-4 Ultrium 1760, LTO-5 Ultrium 3280 and LTO-5 Ultrium 3000.

Options

HP LTO4 Ultrium 1.6TB WORM Data Tape Cartridge	C7974W
NOTE: This data cartridge supports Write-Once Read-Many recording format for LTO-4 and LTO-5 drives. Data recorded to this data cartridge cannot be overwritten.	
HP LTO-5 Ultrium 3TB RW Data Cartridge	C7975A
NOTE: Write and read support for LTO-5 Ultrium 3280 and Ultrium 3000.	
HP LTO-5 Ultrium 3TB WORM Data Cartridge	C7975W
NOTE: This data cartridge only supports Write-Once Read-Many recording format for LTO-5 drives. Data recorded to this data cartridge cannot be overwritten.	
HP LTO-6 Ultrium 6.25TB MP RW Data Cartridge	C7976A
NOTE: Write and read support for LTO-6 Ultrium 6650 and Ultrium 6250	
HP LTO-6 Ultrium 6.25TB BaFe RW Data Cartridge	C7976B
NOTE: Write and read support for LTO-6 Ultrium 6650 and Ultrium 6250.	
HP LTO-6 Ultrium 6.25TB MP WORM Data Cartridge	C7976W
NOTE: This data cartridge only supports Write-Once Read-Many recording format for LTO-6 drives. Data recorded to this data cartridge cannot be overwritten.	
HP LTO-6 Ultrium 6.25TB BaFe WORM Data Cartridge	C7976BW
NOTE: This data cartridge only supports Write-Once Read-Many recording format for LTO-6 drives. Data recorded to this data cartridge cannot be overwritten.	
HPE LTO-7 Ultrium 15TB RW Data Cartridge	C7977A
NOTE: Write and read support for LTO-7 Ultrium 15000	
HPE LTO-7 Ultrium 15TB WORM Data Cartridge	C7977W
NOTE: This data cartridge only supports Write-Once Read-Many recording format for LTO-7 drives. Data recorded to this data cartridge cannot be overwritten	
HPE LTO-1 Ultrium 200GB Storage Media Kit	C8013A
HP LTO-2 Ultrium 400GB Storage Media Kit	C8014A
HP Ultrium Universal Cleaning Cartridge	C7978A

Rack-mount Options

HP StoreEver 1U SAS Rack-mount Kit	AE459B
NOTE: For racked ProLiant servers. No drives included. Accommodates up to two internal SAS half-height drives (such as LTO-4 Ultrium 1760, LTO-5 Ultrium 3000, LTO-6 Ultrium 6250 and LTO-7 Ultrium 15000).	
NOTE: Please refer to web page for further information: http://h18006.www1.hpe.com/products/storageworks/1urackmount/index.html	

Options

Cables and Adapters	VHDCI/Wide 12 Ft. Cable NOTE: for external drives	341177-B21
	5m Wide Differential SCSI Cable 68 pin NOTE: for external drives	328215-001
	10m Wide Differential SCSI Cable 68 pin NOTE: for external drives	328215-002
	HP Ultra 320 SCSI Cable Kit NOTE: for installing Ultra320 SCSI tape drives in the 3U and 5U Rack-Mount Kits)	DW063B
	HP 1m SAS Cable NOTE: Use this cable to connect HPE Ultrium 448, 920, 960, 1760, and 1840 SAS internal tape drives to SAS 4i (SFF8484) connectors.	AE490A
	HP 1m with Power SAS Cable NOTE: Use this cable to connect HPE Ultrium 3280 and 3000 SAS internal tape drives to SAS 4i (SFF8484) connectors.	AE491A
	HP Mini-SAS Cable for LTO Internal Tape Drive NOTE: Use this cable to connect HPE LTO Ultrium internal tape drives to Mini-SAS (SFF8087) ports.	AP746A
	HP SAS External-Min 1x-2M Cable Assembly Kit NOTE: Use this cable to connect HPE SAS external tape devices to HPE SAS controllers with Infiniband (SFF8470) connectors.	AE466A
	HP 1U SAS Ext-Min 1x-4M Cable Assembly Kit NOTE: Use this cable to connect HPE SAS external tape devices to HPE SAS controllers with Infiniband (SFF8470) connectors.	AE468A
	HP SAS Min-Min 1x-2M Cable Assembly Kit NOTE: Use this cable to connect HPE SAS external tape devices to HPE SAS controllers with external Mini-SAS (SFF8088) connectors.	AE470A
	HP SAS MIN-MIN 1X-4M Cable Assembly Kit NOTE: Use this cable to connect HPE SAS external tape devices to HPE SAS controllers with external Mini-SAS (SFF8088) connectors.	AE465A
	HP 1U SAS TP I-E 3HDDs X 1Tape Drive X4M Server Cable Assembly Kit NOTE: This split cable connects internally to SAS Hard Drive Cage (3x) and externally to the tape device (1x) with other connector attaching to HPE SAS controllers with SAS 4i (SFF8484) connectors. The 1x cable occupies additional PCI slot on the server.	AE464A
	HP 2.0m External Mini SAS High Density to Mini SAS Cable NOTE: Use this cable to connect HPE SAS external LTO tape devices to HPE SAS controllers with external Mini-SAS high density connectors as used by HPE H241 Host Bus Adapter.	716191-B21

Technical Specifications

		LTO-5 Ultrium 3280	LTO-6 Ultrium 6650	
Dimensions	Form Factor	5¼-inch full-height	5¼-inch full-height	
	Physical (HxWxD) Internal	3.3 x 5.7 x 8.2 in (8.3 x 14.6 x 20.7 cm)	3.3 x 5.7 x 8.2 in (8.3 x 14.6 x 20.7 cm)	
	Physical (HxWxD) External	4.7 x 8.6 x 11.7 in (12.0 x 21.8 x 29.7 cm)	4.7 x 8.6 x 11.7 in (12.0 x 21.8 x 29.7 cm)	
	Physical (HxWxD) Rack-mount	5.2 x 16.8 x 23.0 in (13.2 x 42.7 x 58.4 cm)	5.2 x 16.8 x 23.0 in (13.2 x 42.7 x 58.4 cm)	
	Shipping (HxWxD) Internal	10.6 x 10.6 x 13 in (27.0 x 27.0 x 33 cm)	10.6 x 10.6 x 13 in (27.0 x 27.0 x 33 cm)	
	Shipping (HxWxD) External	11 x 12.2 x 15.4 in (28 x 31 x 39 cm)	11 x 12.2 x 15.4 in (28 x 31 x 39 cm)	
	Shipping (HxWxD) Rack-mount	15.75 x 23.75 x 33.5in (40.0 x 60.3 x 85.1 cm)	15.75 x 23.75 x 33.5in (40.0 x 60.3 x 85.1 cm)	
	Weight	Out of box, Internal	4.94 lb (2.24 kg)	4.94 lb (2.24 kg)
		Out of box, External	12.28 lb (5.57 kg)	12.28 lb (5.57 kg)
Out of box, Rack-mount		31.6 lb (14.4 kg)	31.6 lb (14.4 kg)	
Shipping, Internal		7.9 lb (3.6 kg)	7.9 lb (3.6 kg)	
Shipping, External		16.1 lb (7.3 kg)	16.1 lb (7.3 kg)	
Shipping, Rack-mount		56 lb (25 kg)	56 lb (25 kg)	
Capacity		Native	1.5 TB	2.5TB
	Compressed (assumes 2:1 data compression for LTO- 5; 2.5:1 compression for LTO-6)	3 TB	6.25TB	
	Buffer Size	256 MB	512MB	
Performance (1Kb = 1,000 bytes)	Native Data transfer rate	140 MB/s with LTO 5 media 120 MB/s with LTO 4 media 80 MB/s with LTO 3 media	160MB/s with LTO 6 media 140 MB/s with LTO 5 media 120 MB/s with LTO 4 media	
	Data transfer rate, compressed (assumes 2:1 data compression for LTO- 5; 2.5:1 compression for LTO-6)	280 MB/s with LTO 5 media 240 MB/s with LTO 4 media 160 MB/s with LTO 3 media	400MB/s with LTO-6 media 280 MB/s with LTO 5 media 240 MB/s with LTO 4 media	
	Burst transfer rate	600 MB/s with 6Gb/s SAS	600 MB/s with 6Gb/s SAS	
	Data rate matching range	47-140 MB/s	54-160 MB/s	
	Data access time	42 seconds typical for LTO 3	50 seconds typical for LTO 6	

Technical Specifications

	(from BOT)	media 50 seconds typical for LTO 4 media 52 seconds typical for LTO 5 media	media
	Rewind time from EOT	< 78 seconds for LTO 3 media < 93 seconds for LTO 4 media < 96 seconds for LTO 5 media	<98s for LTO 6 media
	Rewind tape speed	9 m/s for (LTO 5 and LTO 4 media)	9 m/s for (LTO 6, LTO 5 and LTO 4 media)
	Average load time	<19 seconds (RW) 22 seconds (WORM-initialized) Uninitialized WORM media can take up to 70 seconds	22 seconds (RW)
	Average unload time	<19 seconds (RW) 22 seconds (WORM-initialized) Uninitialized WORM media can take up to 70 seconds	19 seconds (RW) 22 seconds (WORM-initialized) Uninitialized WORM media can take up to 70 seconds
Security	Encryption	AES 256 bit	AES 256 bit
	WORM media support	LTO-5 media	LTO-6 media
Reliability	MTBF	250,000 hours at 100% duty cycle	250,000 hours at 100% duty cycle
	Uncorrected Error Rate	1 in 1x10 ¹⁷ bits	1 in 1x10 ¹⁷ bits
Rewriteable Media Compatibility	Read	LTO Ultrium 5 LTO Ultrium 4 LTO Ultrium 3	LTO Ultrium 6 LTO Ultrium 5 LTO Ultrium 4
	Write	LTO Ultrium 5 LTO Ultrium 4	LTO Ultrium 6 LTO Ultrium 5
WORM Media Compatibility	Read	LTO Ultrium 5 WORM LTO Ultrium 4 WORM LTO Ultrium 3 WORM	LTO Ultrium 6 WORM LTO Ultrium 5 WORM LTO Ultrium 4 WORM
	Write	LTO Ultrium 5 WORM LTO Ultrium 4 WORM	LTO Ultrium 6 WORM LTO Ultrium 5 WORM

Technical Specifications

Tape Format	Recording method	16-channel linear serpentine	16-channel linear serpentine
	Recording format	LTO Ultrium 5 LTO Ultrium 4	LTO Ultrium 6 LTO Ultrium 5
	Data compression	LTO DC dual mode compression (an enhanced version of ALDC)	LTO DC dual mode compression (an enhanced version of ALDC)
	Error detection/correction	Reed-Solomon	Reed-Solomon
	Read Channel Technology	Partial Response Maximum Likelihood (PRML)	Partial Response Maximum Likelihood (PRML)
	Data Tracks	1280	2176
	Data Encoding Method	RLL 32/33	RLL 32/33
	Interface	Interface type	6Gb/s Dual Port SAS
SAS connector		SAS Internal: mini-SAS SFF8482 SAS External: mini-SAS SFF8088	SAS Internal: mini-SAS SFF8482 SAS External: mini-SAS SFF8088

Power Specifications		LTO-5 Ultrium 3280	LTO-6 Ultrium 6650
	Power requirements, Internal (including rack-mount model)	+5V@3.6A (typical) +5V@3.7A (max) +12V@0.7A (typical) +12V@2.2A (max)	+5V@3.5A (typical) +5V@3.9A (max) +12V@0.6A (typical) +12V@2.5A (max)
	Power requirements, External	100 to 240 VAC, 50-60 Hz, auto-ranging, 0.8A max	100 to 240 VAC, 50-60 Hz, auto-ranging, 0.8A max
	Power consumption	7 Watts idle 24 Watts typical 41 Watts max	4.1 Watts idle 24 Watts typical 42 Watts max

Technical Specifications

		Ultrium 920	Ultrium 1760	Ultrium 3000	Ultrium 6250	Ultrium 15000
Dimensions	Form Factor	5¼-inch half-height	5¼-inch half-height	5¼-inch half-height	5¼-inch half-height	5¼-inch half-height
	Physical (HxWxD)	1.6 x 5.7 x 8.1 in	1.6 x 5.7 x 8.1 in	1.6 x 5.7 x 8.1 in	1.6 x 5.7 x 8.1 in	1.6 x 5.7 x 8.1 in
	Internal	(4.1 x 14.5 x 20.6 cm)	(4.1 x 14.5 x 20.6 cm)	(4.1 x 14.5 x 20.6 cm)	(4.1 x 14.5 x 20.6 cm)	(4.1 x 14.5 x 20.6 cm)
	Physical (HxWxD)	3 x 8.8 x 11.7 in	3 x 8.8 x 11.7 in	3 x 8.8 x 11.7 in	3 x 8.8 x 11.7 in	3 x 8.8 x 11.7 in
	External	(7.7 x 22.3 x 29.5 cm)	(7.7 x 22.3 x 29.5 cm)	(7.7 x 22.3 x 29.5 cm)	(7.7 x 22.3 x 29.5 cm)	(7.7 x 22.3 x 29.5 cm)
	Physical (HxWxD)	1.7 x 16.88 x 25.25 in	1.7 x 16.88 x 25.25 in	1.7 x 16.88 x 25.25 in	1.7 x 16.88 x 25.25 in	N/A
	1U Rack-mount	x 42.88 x 64.14 cm)	x 42.88 x 64.14 cm)	x 42.88 x 64.14 cm)	x 42.88 x 64.14 cm)	
	Physical (HxWxD)	N/A	N/A	N/A	N/A	N/A
	3U Rack-mount					
	Shipping (HxWxD)	7.9 x 9.4 x 11.4 in	7.9 x 9.4 x 11.4 in	7.9 x 9.4 x 11.4 in	7.9 x 9.4 x 11.4 in	7.9 x 9.4 x 11.4 in
	Internal	(24 x 31 x 39 cm)	(24 x 31 x 39 cm)	(24 x 31 x 39 cm)	(24 x 31 x 39 cm)	(24 x 31 x 39 cm)
	Shipping (HxWxD)	9.4 x 12.2 x 15.4 in	9.4 x 12.2 x 15.4 in	9.4 x 12.2 x 15.4 in	9.4 x 12.2 x 15.4 in	9.4 x 12.2 x 15.4 in
	External	(24 x 31 x 39 cm)	(24 x 31 x 39 cm)	(24 x 31 x 39 cm)	(24 x 31 x 39 cm)	(24 x 31 x 39 cm)
	Shipping (HxWxD)	12.0 x 23.5 x 33.5 in	12.0 x 23.5 x 33.5 in	12.0 x 23.5 x 33.5 in	12.0 x 23.5 x 33.5 in	N/A
1U Rack-mount	(30.5 x 59.7 x 85.1 cm)	(30.5 x 59.7 x 85.1 cm)	(30.5 x 59.7 x 85.1 cm)	(30.5 x 59.7 x 85.1 cm)		
Shipping (HxWxD)	N/A	N/A	N/A	N/A	N/A	
3U Rack-mount						

Technical Specifications

Weight	Out of box, Internal	3.2 lb (1.45 kg)	3.2 lb (1.45 kg)	3.2 lb (1.45 kg)	3.2 lb (1.45 kg)	3.2 lb (1.45 kg)	
	Out of box, External	10.3 lb (4.65 kg)	10.3 lb (4.65 kg)	10.3 lb (4.65 kg)	10.3 lb (4.65 kg)	10.3 lb (4.65 kg)	
	Out of box, 1U Rack-mount	21.0 lb (9.52 kg)	21.0 lb (9.52 kg)	21.0 lb (9.52 kg)	21.0 lb (9.52 kg)	N/A	
	Out of box, 3U Rack-mount	N/A	N/A	N/A	N/A	N/A	
	Shipping, Internal	5.1 lb (2.3kg)	5.1 lb (2.3kg)	5.1 lb (2.3kg)	5.1 lb (2.3kg)	5.1 lb (2.3kg)	
	Shipping, External	11 lb (5 kg)	11 lb (5 kg)	11 lb (5 kg)	11 lb (5 kg)	11 lb (5 kg)	
	Shipping, 1U Rack-mount	32.9 lb (14.8 kg)	32.9 lb (14.8 kg)	32.9 lb (14.8 kg)	32.9 lb (14.8 kg)	N/A	
	Shipping, 3U Rack-mount	N/A	N/A	N/A	N/A	N/A	
	Capacity	Native	400 GB	800 GB	1.5 TB	2.5TB	6TB
		Compressed (assumes 2:1 data compression for LTO-4 and 5; 2.5:1 compression for LTO-6 and higher))	800 GB	1.6 TB	3 TB	6.25TB	15TB
Performance	Buffer Size	64 MB	128 MB	256 MB	512MB	1024MB	
	Sustained transfer rate, native	60 MB/s	80 MB/s	140 MB/s	160MB/s	300MB/s	
	Sustained transfer rate, compressed (assumes 2:1 data compression for LTO-4 and 5; 2.5:1 compression for LTO-6 and higher)	120 MB/s	160 MB/s	280 MB/s	400MB/s		
	Burst transfer rate	320 MB/s (with Ultra320 SCSI); 300 MB/s (with 3Gb/sec SAS)	300 MB/s (with 3Gb/sec SAS)	600 MB/s (with 6Gb/s SAS)	600 MB/s with 6Gb/s SAS	600 MB/s with 6Gb/s SAS	

Technical Specifications

	SAS)					
Data rate matching range	20-60 MB/s (native)	33-80 MB/s (native)	47-140 MB/s (native)	54-160 MB/s (native)	100-300 MB/s (native)	
Data access time (from BOT)	64 s typical for a 200 GB tape (native)	64 s typical for a 800 GB tape (native)	52 s typical for a 1.5 TB tape (native)	50 seconds typical for LTO 6 media	60 seconds for LTO 7 media	
Average load time	>19 s	>19 s	>19 s	24s	12s	
Average unload time	19 s	19 s	19 s	19s	17s	
Rewind time from EOT	121 s (400 GB tape)	124 s (800 GB tape)	96 s (1.5 TB tape)	98s (2.5TB tape)	114 s (6TB tape)	
Rewind tape speed	5.0 m/s	7.0 m/s	9.0 m/s	9.0 m/s	9.0 m/s	
Reliability	MTBF	250,000 hours at 100% duty cycle	250,000 hours at 100% duty cycle	250,000 hours at 100% duty cycle	250,000 hours at 100% duty cycle	250,000 hours at 100% duty cycle
	Uncorrected Error Rate	1 in 1x10 ¹⁷ bits	1 in 1x10 ¹⁷ bits	1 in 1x10 ¹⁷ bits	1 in 1x10 ¹⁷ bits	1 in 1x10 ¹⁹ bits
Media Compatibility		LTO Ultrium 1 (Read only); LTO Ultrium 2 (Read and Write); LTO Ultrium 3 (Read and Write)	LTO Ultrium 2 (Read only); LTO Ultrium 3 (Read and Write); LTO Ultrium 4 (Read and Write)	LTO Ultrium 3 (Read only); LTO Ultrium 4 (Read and Write); LTO Ultrium 5 (Read and Write)	LTO Ultrium 4 (Read only); LTO Ultrium 5 (Read and Write); LTO Ultrium 6 (Read and Write)	LTO Ultrium 5 (Read only); LTO Ultrium 6 (Read and Write); LTO Ultrium 7 (Read and write)

Technical Specifications

Tape Format	Recording method	16-channel linear serpentine	16-channel linear serpentine	16-channel linear serpentine	16-channel linear serpentine	32-channel linear serpentine
	Recording format	LTO Ultrium 3 LTO Ultrium 2 (for 200 GB tape)	LTO Ultrium 4 LTO Ultrium 3 (for 400 GB tape)	LTO Ultrium 5 LTO Ultrium 4 (for 800 GB tape)	LTO Ultrium 6 LTO Ultrium 5 7 (for 1.5 TB tape)	LTO Ultrium 6 (for 2.5 TB tape)
	Data compression	LTO DC dual mode compression (an enhanced version of ALDC)	LTO DC dual mode compression (an enhanced version of ALDC)	LTO DC dual mode compression (an enhanced version of ALDC)	LTO DC dual mode compression (an enhanced version of ALDC)	LTO DC dual mode compression (an enhanced version of ALDC)
	Error detection/correction	Reed-Solomon	Reed-Solomon	Reed-Solomon	Reed-Solomon	Reed-Solomon
	Read channel technology	Partial Response Maximum Likelihood (PRML)	Partial Response Maximum Likelihood (PRML)	Partial Response Maximum Likelihood (PRML)	Partial Response Maximum Likelihood (PRML)	Partial Response Maximum Likelihood (PRML)
	Data encoding method	RLL 0,13/11	RLL 0,13/11	RLL 32/33	RLL 32/33	RLL 32/33
Interface	Interface type	Ultra320 SCSI (LVDS) or 3Gb/sec SAS	Ultra320 SCSI (LVDS) or 3Gb/sec SAS	6Gb/sec Dual Port SAS	6Gb/sec Dual Port SAS	6Gb/sec Dual Port SAS
	SCSI connector	SCSI Internal: 68-pin LVDS SCSI External: 68-pin HD LVDS SCSI Rack-mount: 68-pin HD LVDS	SCSI Internal: 68-pin LVDS SCSI External: 68-pin HD LVDS	N/A	N/A	N/A
	SAS connector	SAS Internal: mini-SAS SFF8482 SAS External: mini-SAS SFF8088	SAS Internal: mini-SAS SFF8482 SAS External: mini-SAS SFF8088	SAS Internal: mini-SAS SFF8482 SAS External: mini-SAS SFF8088	SAS Internal: mini-SAS SFF8482 SAS External: mini-SAS SFF8088	SAS Internal: mini-SAS SFF8482 SAS External: mini-SAS SFF8088

Technical Specifications

		Ultrium 920	Ultrium 1760	Ultrium 3000	Ultrium 6250	Ultrium 15000
Power Specifications	Power requirements, Internal (including rack-mount model)	+5V@2.5A (typical) +5V@2.5A (max) +12V@0.7A (typical) +12V@2.1A (max)	+5V@2.5A (typical) +5V@2.5A (max) +12V@0.7A (typical) +12V@2.1A (max)	5V@3.5A (typical) +5V@3.7A (max) +12V@0.7A (typical) +12V@1.9A (max)	5V@3.5A (typical) +5V@4.0A (max) +12V@0.6A (typical) +12V@2.5A (max)	5V@4.0A (typical) +5V@4.5A (max) +12V@1.0A (typical) +12V@3.5A (max)
	Power requirements, External	100 to 240 VAC, 50-60 Hz, auto-ranging, 0.7A max	100 to 240 VAC, 50-60 Hz, auto-ranging, 0.7A max	100 to 240 VAC, 50-60 Hz, auto-ranging, 0.7A max	100 to 240 VAC, 50-60 Hz, auto-ranging, 0.8A max	100 to 240 VAC, 50-60 Hz, auto-ranging, 0.8A max
	Power consumption	13 Watts idle 20 Watts typical 33 Watts max	13 Watts idle 20 Watts typical 33 Watts max	7 Watts idle 24 Watts typical 34 Watts max	4.1 Watts idle 24.5 Watts typical 39 Watts max	11 Watts idle 31Watts(typical)

Environmental Specifications	Temperature range	Operating: 50° F to 95° F (10° C to 35° C) if 6 CFM airflow is provided 50° F to 104° F (10° C to 40° C) if 8CFM airflow is provided for Full-Height, 5CFM airflow for Half-Height Non-Operating: -40° F to 151° F (-40° C to 66° C, -40° C to 60° C for LTO-7)
	Non-condensing humidity range	Operating: 20 to 80% RH (Non-condensing, max wet bulb temperature = 26C) Non-Operating: 10 to 95% (90% for LTO-7)RH (Non-condensing, max wet bulb temperature = 26C)

Standards Compliance CSA Certification to C22.2, No.60950 (cCSAus)
 TÜV EN60950 (IEC 60950 and EN60950)
 CE Declaration of Conformity
 FCC 47 CFR Parts 15
 NOM
 VCCI
 C-TICK
 RRL
 BSMI
 GOSH
 CB Certificate and Report (IEC 60950)

Technical Specifications

Front Panel LED Indicators

HPE LTO Ultrium 3 and 4 tape drives have four LED indicators on the front panel:

- Ready
- Drive
- Tape
- Clean

HPE LTO Ultrium 5, 6 and 7 tape drives have five LED indicators on the front panel:

- Ready
- Drive
- Tape
- Clean
- Encryption

Please consult your HPE Ultrium Tape Drive "Getting Started Guide" for more information on how to use these LED indicators for ascertaining drive status and for help in troubleshooting your HPE LTO Ultrium tape drive.





Summary of Changes

Date	Version History	Action	Description of Change
19-Feb-2016	From Version 23 to 24	Changed	Changed a reference in the Option Section, Descriptions updated.
17-Dec-2015	From Version 22 to 23	Changed	Changes made in the Overview and standard features sections
01-Dec-2015	From Version 21 to 22	Changed	Changes made throughout the QuickSpecs
3-Apr-2015	From Version 20 to 21	Changed	Remove 0D1 for internal drives into rackmount kits, SKUs descriptions were updated.
7-Nov-2014	From Version 19 to 20	Changed	Changes made throughout the QuickSpecs.
9-May-2014	From Version 18 to 19	Removed	LTO-4 Ultrium 1840 Tape Drives were removed.
2-May-2014	From Version 17 to 18	Changed	Recommended Support was revised and Optional HPE Support Services was removed.
7-Mar-2014	From Version 16 to 17	Changed	Image correction.
21-Feb-2014	From Version 15 to 16	Changed	Added images.
23-Dec-2013	From Version 14 to 15	Changed	HPE StoreEver LTO-2 Ultrium 448 Tape Drives were removed Performance was revised for LTO-6 Ultrium 6650
13-Sep-2013	From Version 13 to 14	Changed	Changes were made to the following sections: Product Highlights Service and Support Options Technical Specifications
21-Dec-2012	From Version 12 to 13	Changed	Changes were made to the following sections: Options: updated part # COL98A in HPE LTO Ultrim Full Height Tape Drives Technical Specifications: updated Capacity section
4-Dec-2012	From Version 11 to 12	Changed	Changes made throughout the QuickSpecs.
19-Oct-2012	From Version 10 to 11	Changed	Change was made to URL in Service and Support, HPE Support, and Warranty Information section.
13-Aug-2012	From Version 9 to 10	Changed	Changes were made in Overview, Features, Product Highlights, Compatability and Options sections.
28-Oct-2011	From Version 8 to 9	Added	HPE StoreOpen Standalone was added to Product Highlights.

Summary of Changes

23-Sep-2011	From Version 7 to 8	Changed	Updated the following: Linear Tape File Systems (LTFS) updated URL
8-Jun-2011	From Version 6 to 7	Removed	Removed StorageWorks throughout the document.
27-May-2011	From Version 5 to 6	Removed	HPE StorageWorks Ultrium 232 Tape Drive was removed.
29-Apr-2011	From Version 4 to 5	Changed	Updated the following: replaced "Go Connect" link with the "SPOCK" link throughout the entire document.
29-Oct-2010	From Version 3 to 4	Removed	Tape Array 5300 and Redundant, hot-swap power supply and fan for Tape Array 5300 were removed from Rack-mount Options.
27-Sep-2010	From Version 2 to 3	Changed	Key Features and Customer Benefits were moved into Features Software in the Box was changed to Included Software in Product Highlights Related was changed to Optional for the HPE Support Services that will enhance your HPE product experience descriptions and Customer Technical Training, HPE Service Awards and Additional Services Information were completely revised in Service and Support, HPE Support and Warranty Information Software was changed to Upgrade included software to Data Protector Express in Options Value was added to Customer Benefits HPE Data Protector Express Basic was added to Backup Software Support Part numbers were removed from Models
18-Jun-2010	From Version 1 to 2	Changed	Changes made within the Media section of Options.

Summary of Changes

   
Sign up for updates
 Rate this document

© Copyright 2016 Hewlett Packard Enterprise Development LP. The information contained herein is subject to change without notice. The only warranties for Hewlett Packard Enterprise products and services are set forth in the express warranty statements accompanying such products and services. Nothing herein should be construed as constituting an additional warranty. Hewlett Packard Enterprise shall not be liable for technical or editorial errors or omissions contained herein.

Microsoft and Windows NT are US registered trademarks of Microsoft Corporation. Intel is a US registered trademark of Intel Corporation.

The only warranties for Hewlett Packard Enterprise products and services are set forth in the express warranty statements accompanying such products and services. Nothing herein should be construed as constituting an additional warranty. Hewlett Packard Enterprise shall not be liable for technical or editorial errors or omissions contained herein.

For tape drives and media, 1 GB = 1 billion bytes. Actual formatted capacity is less.

c04123270 - 13572 - Worldwide - V24 - 19-February-2016

